

Non-linear Steering Control of Submersible Vehicle

Nenad Popovich, Rajul R. Singh

Abstract- In this paper a mathematical model for the steering control system of submersible vehicle is presented. System has been analysed with numerical and graph-analytical methods. Different types of controllers: P, PI, PD and PID are investigated. Ultimate sensitivity tuning method (Ziegler-Nichols Second method) is used to establish initial controller parameters. Optimal controller parameters have been determined using a Fine tuning method. PD controller has chosen as the best option for the system. Two different criteria are selected to find controller's optimal parameters: Integral Squared Error and Integral Absolute Error. Dynamical behaviour of the system has been simulated by Simulink and Matlab. Non-linear elements are added to protect a rudder/steering gear. A sea current as the dominant disturbance has been implemented in the system and its influence on the system has been investigated.

Keywords- submersible vehicle, steering control, Simulink, optimal parameters, ISE and IAE, non-linear system, disturbance.

I. INTRODUCTION

An unmanned submersible vehicle is a small vehicle that is operational underwater but is controlled either automatically or by a controller remotely operated. Submersible vehicle has a wide range of use, such as oceanic warfare to discover and terminate underwater mines, deep diving for research or environmental hydrographical surveys. This project is more focused on deep diving for research purposes. The submersible vehicle experiences 6 degrees of freedom (Fig.1.), like any other ship or plane, which are:

- Heave is the linear vertical up/down motion.
- Sway is the linear lateral left/right motion.
- Surge is the linear longitudinal forward/back motion.
- Pitch is rotation of a vessel about its y-axis.
- Roll is the rotation of a vessel about its longitudinal x-axis.
- Yaw is the rotation of a vessel about its vertical z-axis.

In this paper we are focused on a heading control (or steering) of the system, which is responsible for direction where the vehicle is traveling. Heading is referred to as a yaw.

Steering in vehicle allows the user or driver to manually set the direction of travel. It also has the ability to correct any errors like over-steer or under-steer, and it can also restrict the impact of disturbances by self-correcting its own inputs. The steering control must be self-sufficient and be able to produce a reliable output that is not affected by system error or disturbances.

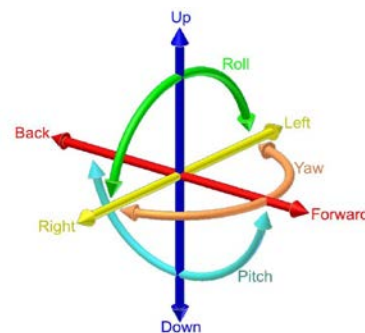

Fig.1. Six degree of freedom in x, y and z axis

II. MATHEMATICAL MODEL

A. Open Loop: Rudder and Submersible Vehicle

Having submersible vehicle by itself is meaningless. That means it has to be used with a steering gear (actuator), i.e. a rudder. Mathematical model of the open loop: rudder-submersible vehicle, with their transfer functions is shown on Fig.2., [1].

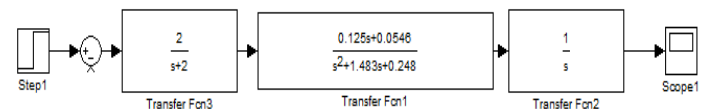

Fig.2. Open loop model

Nenad Popovich, M.Sc, Eng. (Hons) is with the Auckland University of Technology, New Zealand e-mail: nenad.popovich@aut.ac.nz
Rajul R. Singh, B.Eng. (Tech.) is also in New Zealand e-mail: rajulravideep@yahoo.com

A response of the open loop system shows an unstable system, because of the integrator in the submersible vehicle transfer function (type 1 of the system). See Fig.3.

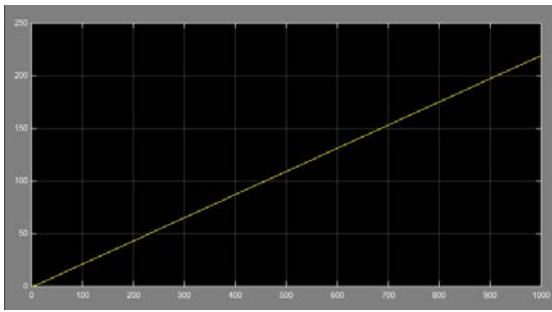

Fig.3. Open loop response to a unit step input.

To stabilize system response, it is necessary to make a closed loop system with a negative feedback.

B. Closed Loop System without Controller

Mathematical model of the closed loop system, including: rudder (actuator) and submersible vehicle is presented in the Fig.4.

Note: In this stage, no controller is involved in the closed loop system.

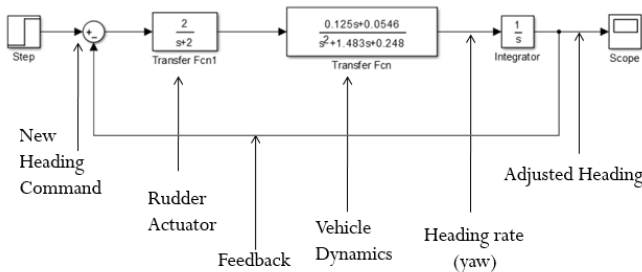

Fig.4. Simulation model of the closed loop system

It can be seen (in Fig.5), response of the closed system is now stable, with a settling time about 30 seconds and an overshoot about 10%. Of course, the output is not an “ideal” and has to be improved by implementing a right controller with the optimal parameters.

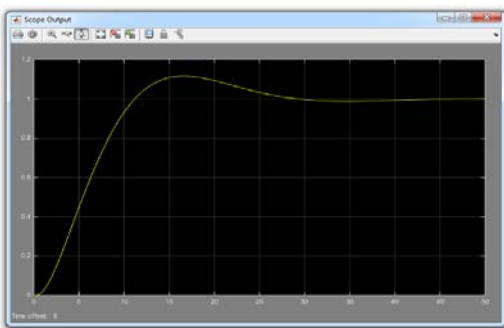

Fig. 5. Closed loop response

The closed loop system utilizes a feedback to stabilize the system. Feedback gives the system ability to check if the final

output is different to the input. The output and output are compared and the difference, known as a dynamic error is feedback into the system. The process takes place “infinitely” and any changes in the system will be corrected through the feedback.

To find a range of stability for the system, two methods have been used: analytical method (Routh’s stability criterion), based on the coefficients of the characteristic equation, and a graph-analytical method (Root Locus-Evan’s method), based on the closed loop poles of the system for the controller proportional gain from zero to infinity.

The Root Locus are shown on the figure below:

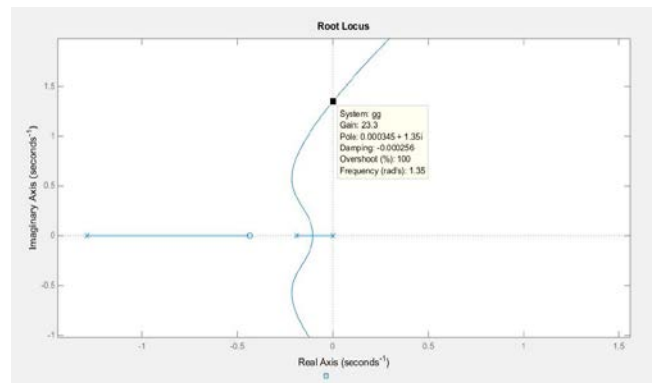

Fig.6. Root Locus

Both methods give the same range of stability for the closed loop system (from zero to critical gain, which is 23.3). When the ultimate gain, is reached, the system becomes unstable, and response has a sustain oscillation. It happens when dominant, complex conjugate poles are on the imaginary axis of the s-plane. At that point system shows its inherently instability. It is a good starting point for designing controller by implementing Ultimate Sensitivity tuning method (Second Ziegler-Nichols tuning method) and finding controller suitable parameters.

III. DESIGNING CONTROLLER

The first step in designing controller is to select a right type of controller. That means, it is not always necessary to select three-term controller (PID-Proportional-Integral-Derivative) for every single system, if two-term (PI, PD) or one-term (P, I) controller can satisfy “all” requirements for a “good control”.

A. General Rules for Selecting Controller

There are some well accepted guidance regarding the selection of the controller type to obtain a desired response [2], [5]:

- Obtain an open loop response and determine what needs to be improved (it has been already mentioned in the previous sections, regarding overshoot, steady state error, rise and settling time).

- Add a proportional control to improve the speed of the system response (particularly a rise time).
- Add a derivative control to improve the overshoot and the transient response.
- Add an integral control to eliminate the steady state error.
- Adjust each of those controller's parameters until obtain a desired overall response.
- And last, but not the least: make a controller as simple as possible.

The most likely effect of each of the controller parameters: K_p , K_i and K_d (proportional, integral and derivative gain constants, respectively), on the closed loop system response, can be tabulated, as in Table 1, [7].

Table 1.

CL RESPONSE	RISE TIME	OVERSHOOT	SETTLING TIME	S-S ERROR
K_p Increase	Decrease	Increase	Small Change	Decrease
K_i Increase	Decrease	Increase	Increase	Eliminate
K_d Increase	Small Change	Decrease	Decrease	Small Change

Note: Those correlations may not be exactly accurate, because K_p , K_i and K_d are dependant on each other. In fact, changing one of those parameters can change the effect of the other two. For that reason, the table should be use as a reference or a guidance, only. [4], [7].

Referring to Fig.5, it can be seen that PD controller has to be involved in the system. Derivative part mainly for obtaining less or no overshoot (if possible), as well as a faster response (Proportional part).

In many papers, dealing with marine vehicle control systems, there are recommendations for using PD controller, if the steady state error is not a dominant criteria, or if you already have one integrator in the system's transfer function, i.e., if the system is "type-1" (as it is in our case). Involving integral controller could leads to more oscillatory and less stable (even unstable) response of the system. It can be used if we need a ramp input, which will give the steady-state error without additional integrator in the system. However, we are considering a step input, only. The right balance between PD components is essential for the "optimal control" [1], [2].

B. Ziegler-Nichols Tuning Methods

Having in mind previously mentioned, it is necessary to establish initial settings of PD controller.

There are many different tuning methods that can be applied to the system. One of the simplest and fastest (but not necessarily the most reliable) is Ziegler-Nichols First tuning method, that can be implemented even if the transfer function of the system is unknown. Its is an open loop tuning method based on the response of the system (i.e. a reaction of the system) to a unit step input. The response has to be in, so called "S-shape", to

be able to find necessary parameters (L-delay and T-time constant of the system) and to calculate controller parameters. However, in our case when the system is a type-1, it is not possible to get response of the system in "S-shape", which means we need to use some another method, for example: Ultimate Sensitivity tuning method (Ziegler-Nichols Second tuning method).

This method is a closed loop method and it starts with Proportional controller (i.e. disable integral and derivative controller). Then, start up the process with the proportional gain at "low level" and gradually increase gain settings until the system starts to oscillate (i.e. having a sustain oscillations, with period, $P_u = 4.7$) in Fig.7. At that point record the gain, which is the ultimate gain or critical gain.

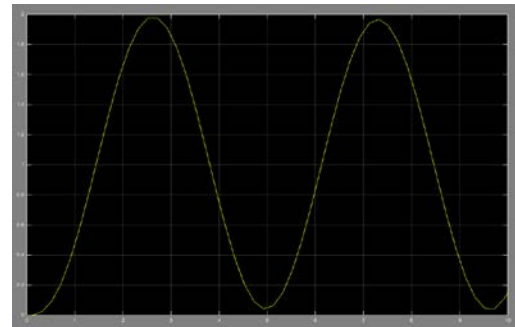

Fig.7. Sustain oscillation response

Based on P_u and G_u (already established in the previous section), determine the controller settings for PD controller from Table 2.

Table 2.

PID	PI	P
$K_p = 0.65G_u$	$K_p = 0.45G_u$	$K_p = 0.5G_u$
$T_I = \frac{P_u}{2}$	$T_I = \frac{P_u}{1.2}$	
$T_D = \frac{P_u}{8}$		

Note: Ziegler-Nichols Second tuning method is based on empirical formula and it is not so accurate. That means, calculating controller's parameters does not lead us to an optimal system, and rather gives us a range of the controller's parameters for a fine tuning.

From Table 2. Parameters for P, PI and PID controllers have been calculated and responses for those three cases are shown on Fig.8.1, Fig.8.2 and Fig.3, respectively.

Expectedly, the PID control system has produced an output that has far less oscillation compared to P and PI and also has increased stability. It should be noted that the PID system has

decreased overshoot to about 45% and settling time down to 12 seconds. This seems, PID is a good controller option to be used for steering control system. It can be further fine-tuned with the aid of the Table 1. to give a system that has minimum to zero overshoot and a faster settling time with zero steady state error.

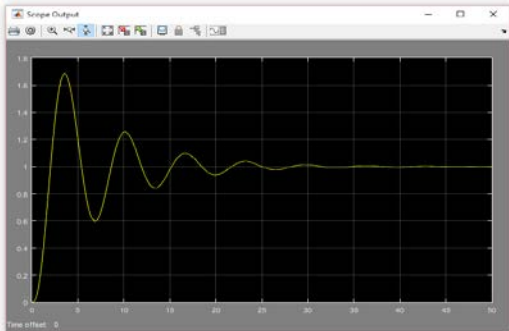

Fig.8.1. System response with P controller $K_p = 11.63$

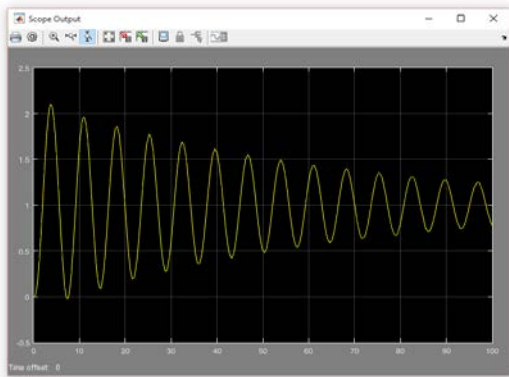

Fig.8.2. System response with PI controller $K_p=10.47$ and $K_i=K_p/T_i=2.67$

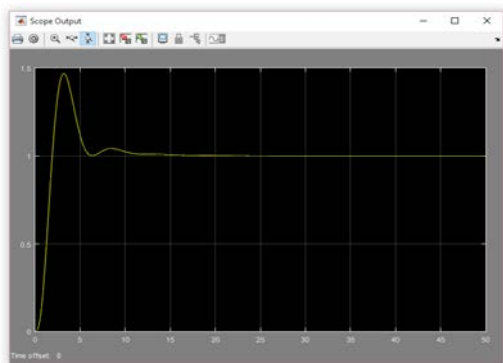

Fig.8.3. System response with PID controller. $K_p=15.12$, $K_i=K_p/T_i=6.43$ and $K_d=K_p*T_d=8.88$

C. Fine Tuning

Fine tuning has been performed by using Systematic tuning method (or a trial and error method). After several attempts, systematic tuning method gives further improvement of overshoot and settling time. The system now has an overshoot value of approximately 17%, and a very fast response (settling time of less than 7 seconds and a rise time of approximately 2 seconds), Fig.9.

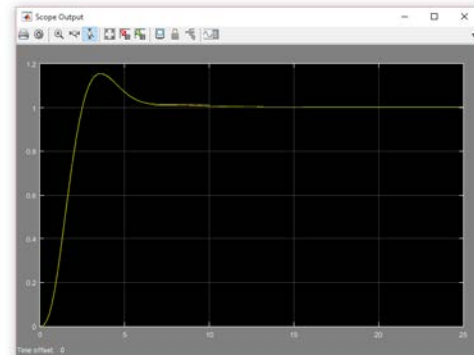

Fig.9. System response after a fine tuning

However, a very fast response will put the mechanical elements and rudder under a lot of strain. Vehicles that travel through or on water generally tend to have slower turning response and exhibit minimum to zero overshoot. Cruise ships and submarines mostly steer through the seas by moving in straight lines or large simple curves.

On the other hand, system is still producing overshoot of about 17% which is not reasonable for a submersible vehicle. Overshoot can be further reduced by taking out the integral controller component. It can be done, because the transfer function for the steering control already has an integrator element, so removing the integral component should not affect steady state error or settling time.

All those figures (Fig.8.1, Fig.8.2, Fig.8.3, Fig.9 and Fig.11) are obtained from a simulation model as on Fig.10 with different parameters of P, PI, PID, [3].

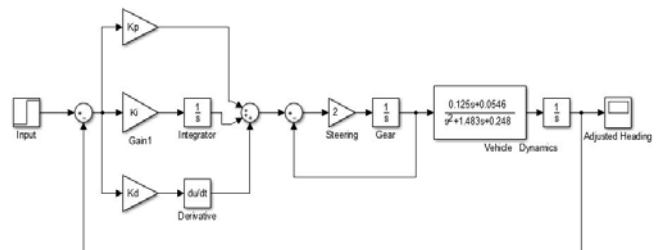

Fig.10. Simulation model with PID controller.

D. System with PD Controller

If we remove Integral part of PID controller from Fig.10. then we have a PD controller.

Parameters of PD controller can be further changed to produce an “ideal response”. Proportional (K_p) and Derivative (K_d) gains were individually increased to give an “ideal” response (on Fig.11), with faster response and no overshoot.

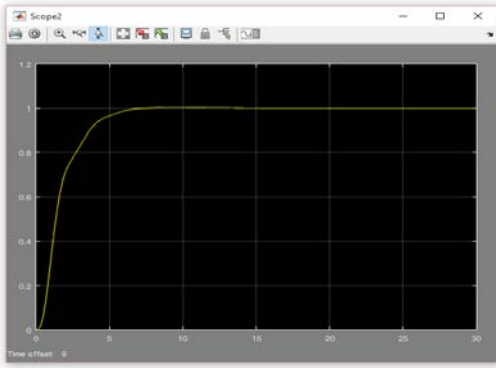

Fig.11. “Ideal” system response with PD controller. ($K_p=20$ and $K_d=30$)

E. “Derivative Kick” and “P+D” Controller

Very often PD controller (Fig.12) produces a “derivative kick”, which has a huge signal from D part of the controller and it could damage a final control element (actuator, or in our case: a steering gear).

One method to prevent “derivative kick” is using: “P+D” configuration (Fig.13) for the PD controller, [8], [9], [10].

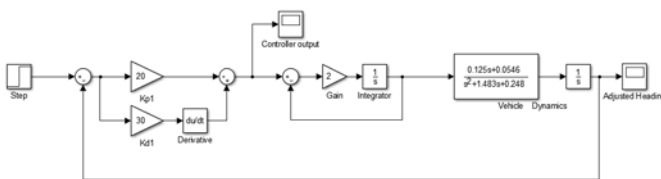

Fig.12. PD controller configuration.

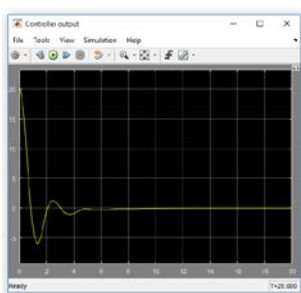

Fig.12.1. Controller Output

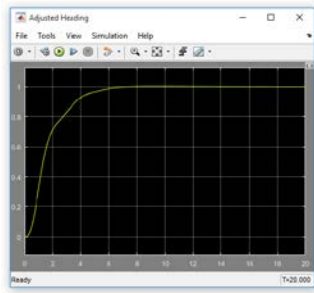

Fig.12.2. Adjusted Heading

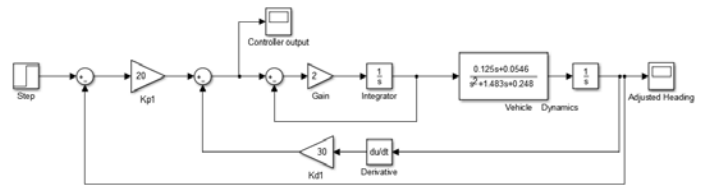

Fig.13. “P+D” Configuration

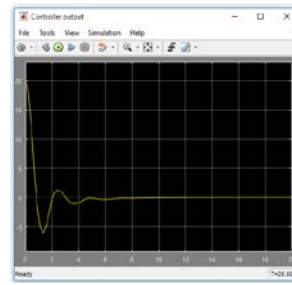

Fig.13.1. Controller Output

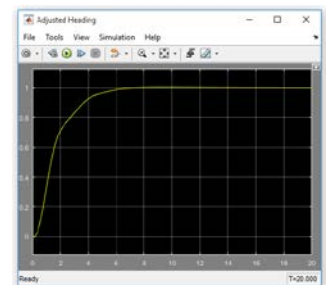

Fig.13.2. Adjusted Heading

Note: Characteristic equation (1) for both models is the same: meaning they have same denominator of the closed loop transfer function, which dictates dynamic behavior of the system (especially stability as the most important parameter).

$$s^4 + 3.483s^3 + 10.71s^2 + 8.772s + 2.184 = 0 \quad (1)$$

From Fig.12.1, 12.2, Fig.13.1 and 13.2 it is obvious that controller outputs and adjusted headings are same for both configurations.

“P+D” would be very useful in the case of a huge signal of the controller output, mainly caused by derivative component. If this second configuration significantly reduces “derivative kick”, then it is not necessary to introduce non-linear elements, i.e. saturation blocks (discussed in later chapter) as the protection for a steering gear. Thus, it is possible to maintain a linear system, rather than replace it by a non-linear system, which drastically complicates design (non-linear theory cannot be mathematically implemented, and a simulation is the only option), [5], [10].

F. Cost Functions

The cost functions [4] are used in order to find the most efficient values for K_p and K_d . Those criteria will not necessarily produce the best output response with the smallest overshoot nor with the fastest system. They are simply used to determine gain values that will make the steering control cost more efficient. In the industry, those criteria are used mostly to lower fuel consumption. The name: “Cost Function” is derived from the meaning of the least cost as possible. They are calculated by using following formulae for Integral Squared Error (ISE) and Integral Absolute Error (IAE), respectively.

$$ISE = \int_0^t (\Delta\psi)^2 dt \rightarrow \min \tag{2}$$

$$IAE = \int_0^t |(\Delta\psi)| dt \rightarrow \min \tag{3}$$

Position for calculating cost functions in the simulation model is shown on Fig.14:

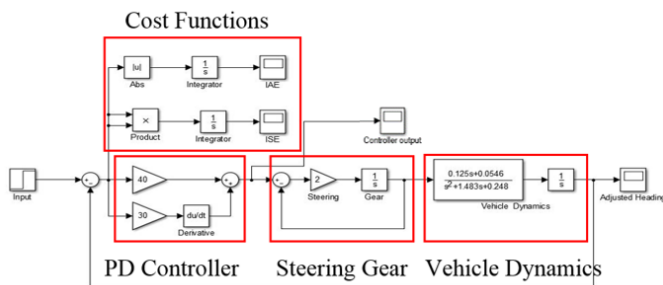

Fig.14. Simulation model for calculating cost functions.

The simplest method to find a minimum cost function is to start with P and D gains at zero and then increasing them one by one until a minimum (optimum) value been found.

By varying those parameters, it can be found that bigger K_p and K_d produce a smaller cost function. However, too big values could lead to unstable system. That means, a balance has to be made between minimum cost function and stability. It was decided that the $K_p=40$ and $K_d=30$ would be “ideal” for a submersible vehicle since it still has a low settling time (less than 5 seconds) and rise time less than 1 second, while overshoot is not significant (about 7%).

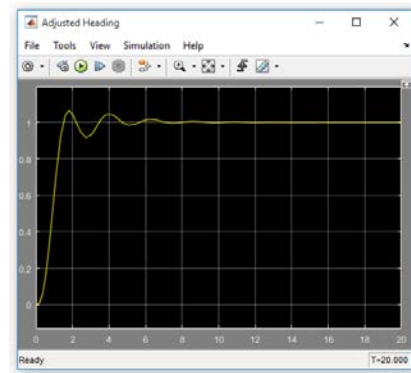

Fig.15. System response with a minimum ISE and IAE cost functions.

Simulation results of calculations cost functions are tabulated below:

Table 3.

K_p	K_d	ISE	IAE
20	10	1.015	1.744
	20	0.958	1.348
	30	1.098	1.774
	40	1.297	2.259
	50	1.517	2.761
30	10	1.139	2.461
	20	0.799	1.231
	30	0.825	1.221
	40	0.930	1.530
	50	1.061	1.851
40	10	1.818	4.515
	20	0.779	1.481
	30	0.708	1.037
	40	0.755	1.160
	50	0.837	1.401

As seen above on Table 3, when the value for K_d is increase while K_p is kept the same, a local minimum can be observed . (yellow marks for local minimums and green marks for the global minimum).

The ideal values for both criteria are $K_p=40$ and $K_d=30$.

G. Non-linear Elements (Saturation Blocks)

Non-linearities are added to a system to protect the machanical component from being damaged. As discussed earlier, there is a high, so called “derivative kick” experienced on the input to the steering gear. This high change of rate can cause damages to the vehicle’s machanical elements and a non-linear element is added to restrict this movement. It works by allowing only for a certain range of values to pass through, [7], [8].

The first saturation block (Protection, in Fig.16) has a upper limit of 3 and a lower limit of -1. Usually cutting down

a big proportion tends to make the system unstable, but in our case, system is stable with just 10% overshoot (slightly bigger than in the system without such limit).

Similarly, the second saturation block (Rate limiter, in Fig.16) has an upper limit of 1 and a lower limit of -1. That rate limiter protects steering gear (rudder), so that rudder doesn't change too fast which can lead to its damage.

Simulation results of calculations cost functions are tabulated below:

Table 4

Kp	Kd	ISE	IAE
20	10	3.484	5.848
	20	2.565	4.032
	30	2.347	3.168
	40	2.390	3.258
	50	2.495	3.671
30	20	3.308	5.521
	30	2.688	4.347
	40	2.415	3.570
	50	2.344	3.122
	60	2.368	3.153
40	50	2.497	3.860
	60	2.376	3.393
	70	2.344	3.107
	80	2.358	3.077
	90	2.399	3.335

A local minimum can again be observed to decrease as the Kp value is increased. And again, too big values could lead to more oscillatory system, and even unstable system. The ideal values of Kd, for ISE is Kd=70 and for IAE is Kd=80, while Kp remain the same as in the linear model.

ISE Criteria for Kp=40 and Kd=70:

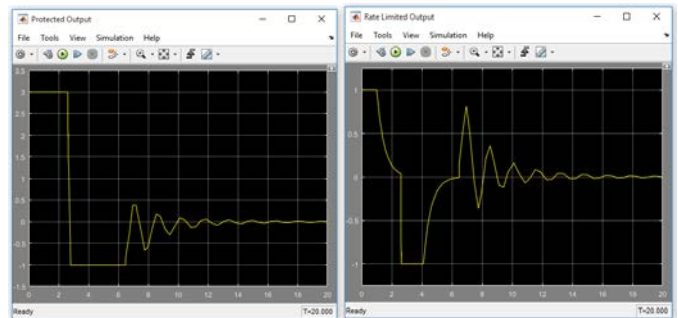

Fig.16.1. Protected Output

Fig.16.2. Rate Limiter Output

IAE Criteria for Kp=40 and Kd=80:

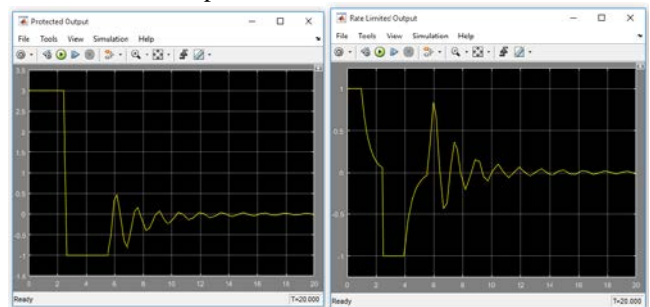

Fig.16.3. Protected Output

Fig.16.4. Rate Limiter Output

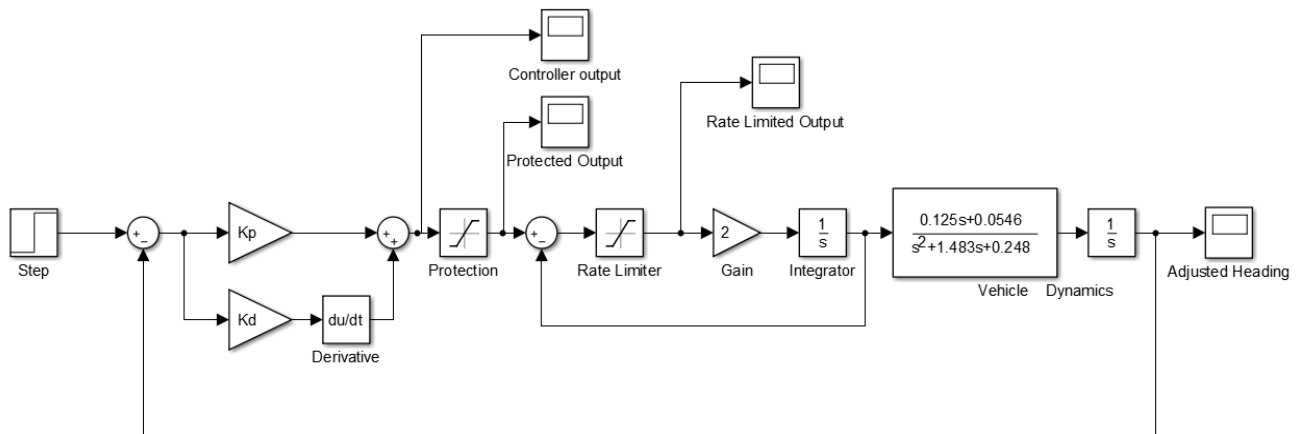

Fig.16.PD Controller with Protection and Rate Limiter

H. Disturbance

Every control system is prone to outside interference which is referred to as disturbance. The submersible vehicle would have to deal primarily with sea currents as it will be submerged whenever it is being used. Disturbance is represented by a step input set at 0.1. Since the initial step value of the system is 1, the disturbance value of 0.1 suggests that the object will experience 10% extra force in the direction of travel or a push backwards (if it sets at -0.1). This external disturbance can cause the system to have steady state error, as well as more oscillation of the output. Very high values of disturbances can cause instability.

Simulation results of calculations cost functions are tabulated below:

Table 5

Kp	Kd	ISE (0.1)	IAE (0.1)	ISE (-0.1)	IAE (-0.1)
20	20	2.633	4.360	2.547	3.856
	30	2.300	3.292	2.408	3.160
	40	2.317	3.165	2.465	3.427
	50	2.418	3.549	2.576	3.840
	60	2.550	3.941	2.711	4.243
30	30	2.790	4.713	2.637	4.110
	40	2.413	3.779	2.445	3.469
	50	2.292	3.216	2.409	3.118
	60	2.298	3.042	2.445	3.326
	70	2.355	3.334	2.509	3.648
40	50	2.537	4.139	2.501	3.702
	60	2.352	3.550	2.422	3.329
	70	2.289	3.176	2.410	3.096
	80	2.291	2.991	2.436	3.277
	90	2.342	3.191	2.476	3.487

In the final simulation (Fig.17), along with two non-linear elements a second input was added after the steering gear to act as a disturbance in the form of the sea current.

The ideal values for Kp and Kd for Disturbance set at 0.1 are: Kp=40 and Kd=70 for ISE criteria and Kp=40 and Kd=80 for IAE criteria (green marks).

The ideal values for Kp and Kd for Disturbance set at -0.1 are: Kp=20 and Kd=30 for ISE criteria and Kp=40 and Kd=70 for IAE criteria (green marks).

ISE (0.1)

IAE (0.1)

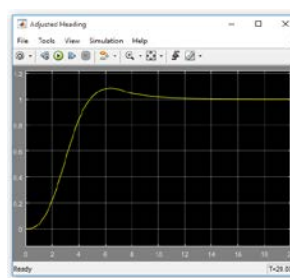

Fig.17.1.Kp=40 Kd=70

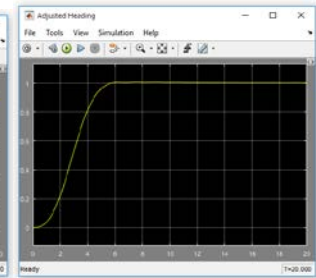

Fig.17.2.Kp=40 Kd=80

ISE (-0.1)

IAE (-0.1)

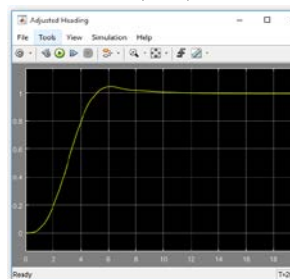

Fig.17.3.Kp=20 Kd=30

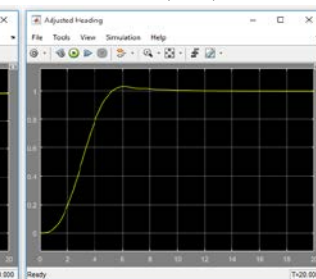

Fig.17.4.Kp=40 Kd=70

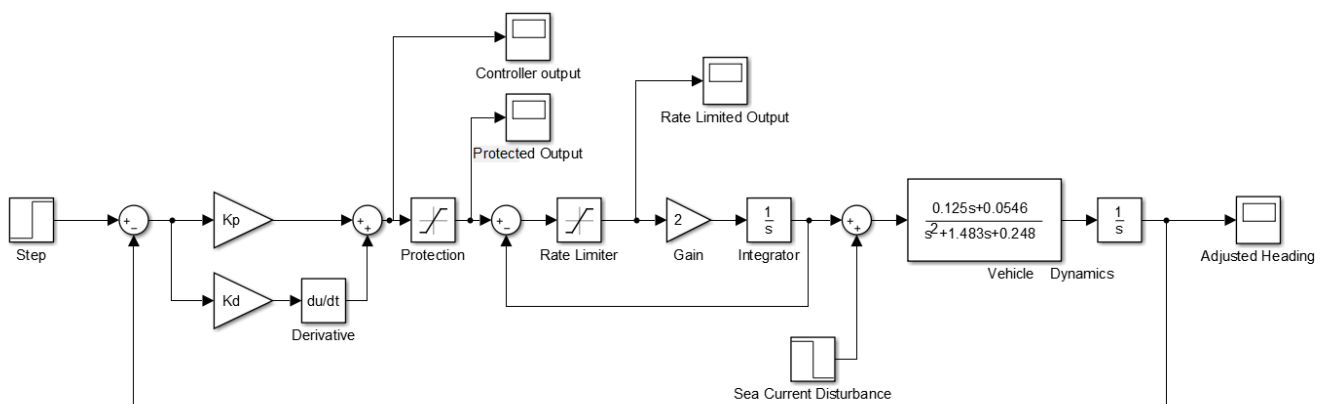

Fig.17.Simulation model for the whole system

IV. CONCLUSION

PD controller has been selected for the heading control of unmanned submersible vehicle as the best choice. Parameters of the controller have been determined using Ziegler-Nichols tuning method, as well as a Systematic (trial and error) tuning method for a fine tuning. Cost functions have been defined as ISE and IAE criteria of the most cost effective steering control. Parameters of PD controller have been found. Two limiters (protection and rate-limiter) have been introduced in the system to see how they influence a selection of optimal controller parameters. Sea current as a dominant disturbance has been implemented in the system model. Further research can be focused on testing a real physical object to see if it does react like it was suggested in the simulation. Also, more process variables should be introduced: i.e. pitch and speed control.

ACKNOWLEDGMENT

We would like to extend our sincere gratitude to Mitchell Singe and Shahil Din who were part of the Final Year Project group that carried out the research "Heading Control of Unmanned Submersible Vehicle", AUT, 2015.

REFERENCES

- [1] N.S. Nise, "Control Systems Engineering", Wiley, 7th ed. 2015.
- [2] K. Ogata, "Modern Control Engineering", Prentice Hall, 5th ed., 2010.
- [3] R. Singh, M. Singe, and S. Din: "Heading Control of an Unmanned Submersible Vehicle", Final year project, Auckland University of Technology, 2015.
- [4] N. Popovich, D. Bosovic, "Submarine Optimal Depth Control applying Parseval's Theorem", Proceedings of the Fourth International Conference on Advances in Mechanical and Automation Engineering-MAE2016, ISBN: 978-1-63248-102-3, pp. 6-11, 2016.
- [5] R.C. Dorf, R.H. Bishop, "Modern Control Systems", Prentice hall International, 12th ed., 2011.

- [6] N. Popovich, S. Lele, and N. Garimela, "Non-linear Model of Submarine Depth Control Systems", WSEAS Transaction on Systems, Issue 8, Vol.5, pp. 1912-1918, 2006.
- [7] N. Popovich, S. Lele and N. Garimella, "Submarine Depth Control", proceedings of the 3rd WSEAS/ISME Int. Conf. on Electrosience & Technology For Naval Engineering, Greece, pp. 1-5, 2006.
- [8] N. Popovic, "Synthesis of the Ship Automatic Steering Control System", Proceedings of International AMSE Conference, Modelling & Simulation", Istanbul, Turkey, AMSE Press, Vol. 4A, pp. 141-148, 1988.
- [9] N. Popovic, "Dynamical Behaviour Analysis of the digital Ship Course Control System", Proceedings of the IASTED International Symposium, taormina, italy, pp. 23-25, 1986.
- [10] N. Popovic, "Digitalni System Automatskog Vodenja Broda, M.Sc. Thesis (in Serbo-Croatian language), University of Zagreb, 1984.
- [11] "PID Controller", Control Tutorials for Matlab, Michigan University.
- [12] N. Popovich, R. Singh, "Heading Control of Unmanned Submersible Vehicle", 2016 Third International Conference on Mathematics and Computers in Science and in Industry, Chania, Crete, Greece, August 27-29, 2016. (publication pending).
- [13] G. F. Franklin, J.D. Powell, and A. Emami-Naeini, "Feedback Control of Dynamic Systems, Addison-Wesley Publishing Company, 3rd ed. 1994.
- [14] B.C. Kuo, "Automatic Control Systems", John Wiley & Sons, Inc., 7th ed., 1995.
- [15] T. Fossen, "Guidance and Control of Ocean Vehicle", John Wiley, 1999.
- [16] N. E. Mastorakis, "Modeling dynamical systems via the Takagi-Sugeno fuzzy model," Proceedings of the 4th WSEAS International Conference on Fuzzy sets and Fuzzy Systems, Udine, Italy, March 25-27, 2004.
- [17] J. Quartieri, N.E. Mastorakis, G. Iannone, C. Guarnaccia, S D' Ambrosio, A. Troisi, and T.L.L. Lenza, "A review of traffic noise predictive models", Proceedings of the 5th WSEAS International Conference on Applied and Theoretical Mechanics, December 14-16, 2009, Puerto De La Cruz Canary Islands Spain.

Nenad Popovich was born in Croatia in 1955. He graduated at the University of Zagreb, Croatia in 1978 and earned M.Sc. in Eng. (major in Control Systems) in 1984 at the same university. He has worked at five universities. Currently, he is a senior lecturer at the Auckland University of Technology, New Zealand in area of Control Systems Engineering. He has seventeen International conference and journal papers, as well as eight scientific research projects. He is a member of Croatian Society of Engineers and Technicians.

Rajul Ravideep Singh was born in Fiji in 1993. He earned his Bachelors of Engineering Technology (Electronics) from Auckland University of Technology, New Zealand in 2016.